











Science Center (SC)

Emergency Features

-   Class D Fire extinguisher
-  Fire Extinguishers Located in Penthouse or Mechanical Room
-  Fire Extinguishers
-  Pull Station
-  Automated External Defibrillators
-  Evacuation Routes
-  Severe Weather Shelter Areas
-  Hazardous Waste
-  Spill Kit

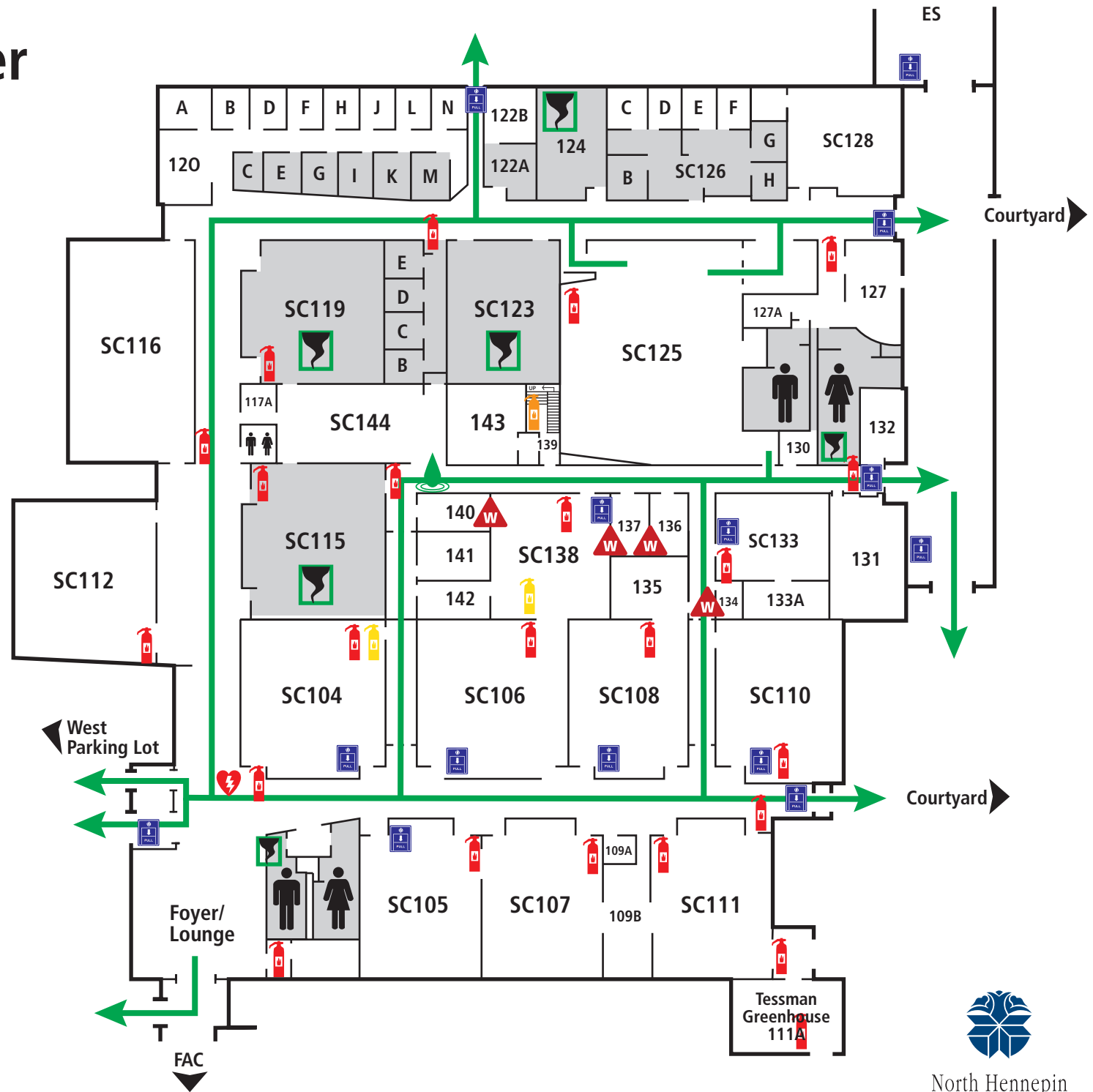

EVACUATION MAP

Updated 1/27/2020